

"TRADER" SERVICE SHEET

584

PHILIPS 630A

SUPERINDUCTANCE AC RECEIVER

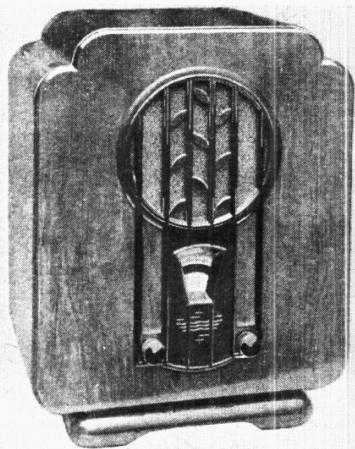

TWO band-pass filter circuits, both tuned to signal frequency, are employed in the Philips 630A. The receiver is a 5-valve (plus rectifier) 2-band TRF "Superinductance" model, and a special type of adjustment provides for AC mains of 100-250 V, 40-100 C/S. Generally speaking, the Continental Philips models 620A, 545, 546 and 600A employ the same chassis, although there are small differences in these models.

Release date: 1932.

CIRCUIT DESCRIPTION

Aerial input via impedance matching circuit **C1**, **C2** to capacity coupled band-pass filter. Primary coils **L1**, **L2** are tuned by **C37**; secondary coils **L3**, **L4** by **C40**. Bottom coupling by **C5** (MW) and **C4**, **C5** (LW), with top coupling by very small capacity **C3**. Two alternative aerial input sockets, **A1** and **A2**, are provided. Input from **A2** is direct, while input from **A1** is capacity coupled to **A2**. The coupling between the two sockets consists only of their mutual capacity.

First valve (**V1**, Mullard metallised **S4VB**) is a variable- μ RF tetrode operating as signal frequency amplifier with gain control by potentiometer **R4**, which varies applied GB. The earthy end of the band-pass filter is returned to **V1** cathode, and to chassis via **C7**, and the GB, which is developed across the fixed resistance **R5** and part of the potentiometer **R4**, is applied by **R1** and the band-pass secondary coils. **R1** is included to avoid short-circuiting **C4**, **C5**.

Tuned-anode RF coupling, in which a second capacity coupled band-pass filter is employed, couples **V1** to second valve (**V2**, Mullard metallised **VMS4B**), another RF tetrode operating as signal frequency amplifier, but this time with fixed bias.

Band-pass primary coils **L5**, **L6** are tuned by **C43**; secondaries **L7**, **L8** by **C46**. Bottom coupling by **C11** (MW) and **C10**, **C11** (LW), with top coupling by **C9**, and

the filter is a replica of the aerial filter circuit, and is returned to chassis via **C8**, while **H1** is fed via **R6**, **R7** and the band-pass primary coils to **V1** anode, **R7** being inserted to avoid shorting **C10**, **C11**.

Screen grid potential for **V1** is obtained from a potential divider **R2**, **R3**, and that for **V2** is obtained from a second potential divider **R9**, **R10**. The two potential dividers are connected in parallel, and their combined current, together with screen and anode currents of **V1**, provide the current which flows through **R4**.

Choke-capacity RF coupling by **L9**, **C17** and **R14** between **V2** and triode valve (**V3**, Mullard metallised **244V**), which operates as leaky grid detector with **C17**, **R14**. On LW, **C16** is connected via **S5** and **C14** across **L9**. Provision for connection of gramophone pick-up, via voltage-limiting resistance **R13**, across **R14**.

Resistance-capacity coupling by **R17**, **C23** and **R19**, via RF filter **C20**, **R18**, **C21**, between **V3** and a second triode valve (**V4**, Mullard **244V**), which operates as AF amplifier. Two-position tone control by **C22** and **S6**. Rigid decoupling in **V3** anode circuit by **R15**, **C18** and **R16**, **C19**.

Resistance-capacity coupling by **R21**, **C26** and **R23** between **V4** and pentode output valve (**V5**, Mullard **PM24A**), with directly heated cathode. Choke-capacity coupled output by **L10**, **C31**, **C32** to transformer-coupled low impedance moving coil speaker. Provision for connection of

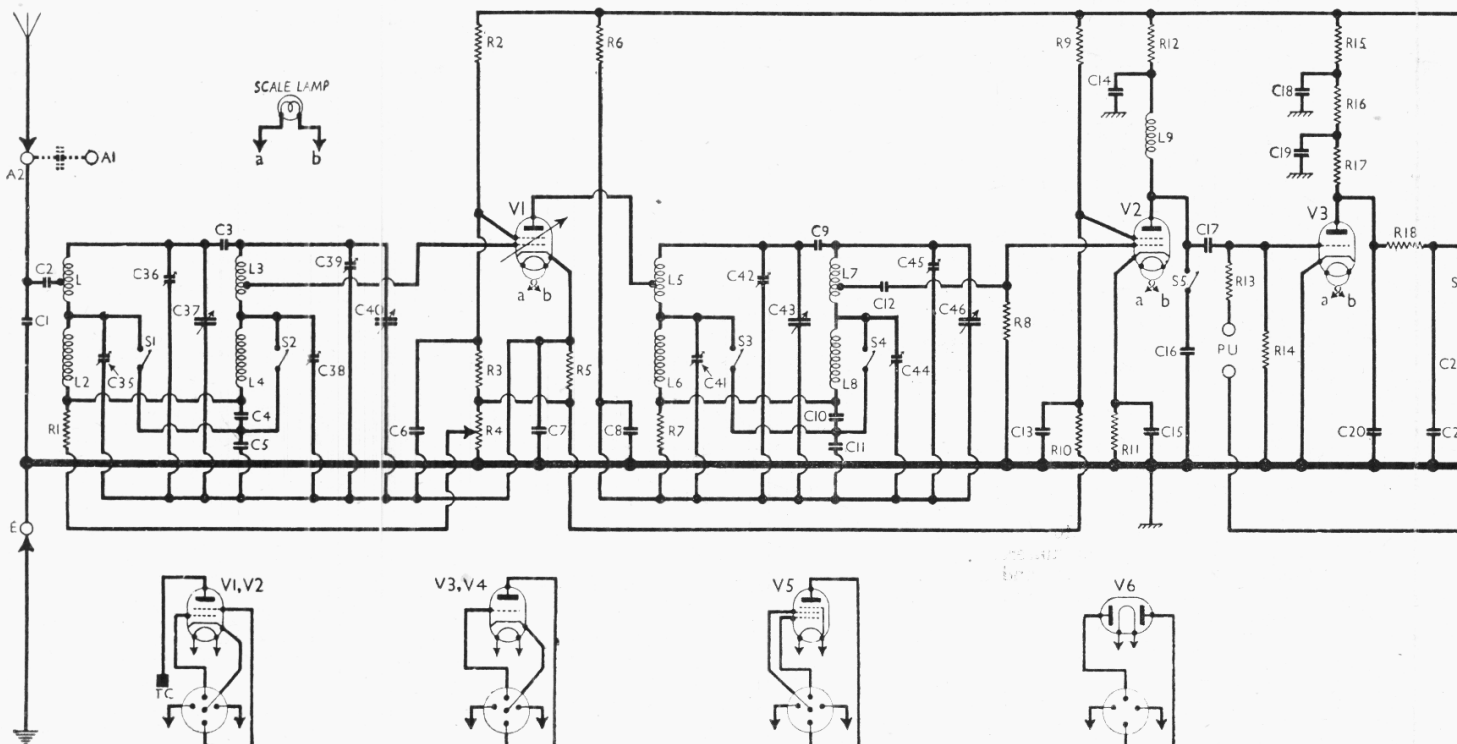

Under-chassis view. The undersides of the two condenser blocks are indicated and marked "A" and "B." It is in the position shown here that they are viewed in the drawings showing the connecting panels in cols. 3 and 4 overleaf. The construction of the special tuning and trimming condensers C35-C46 is described under "General Notes." Resistances R25 and R26 are wire wound.

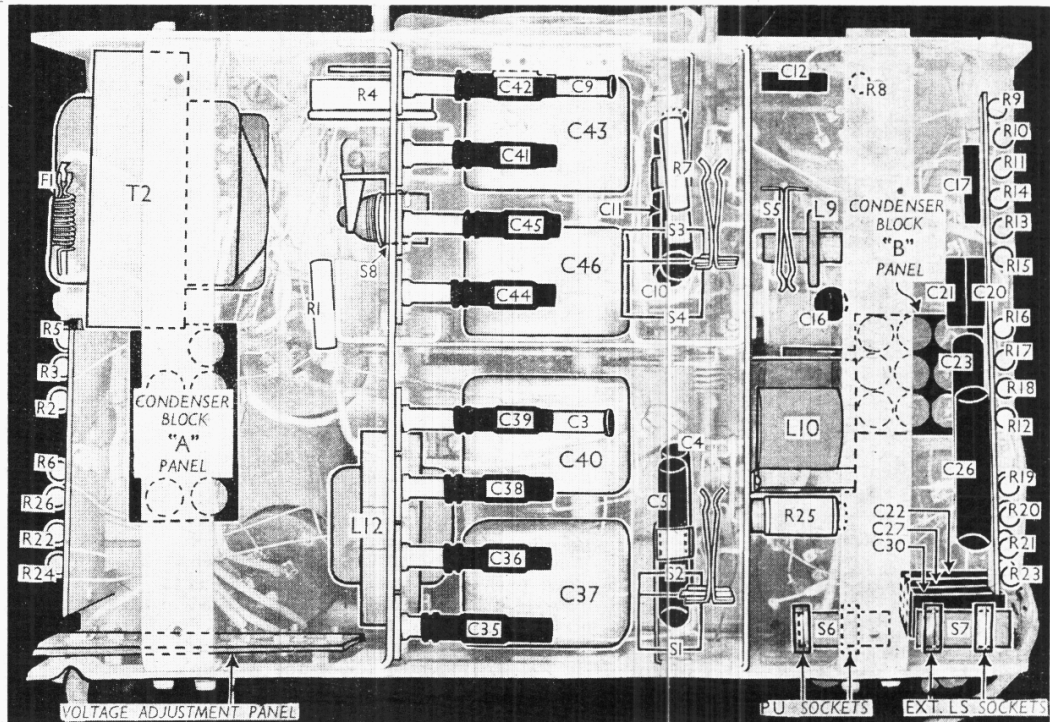

high impedance external speaker by sockets across the output at C31, C32, while switch S7 permits internal speaker to be muted if desired. Fixed tone correction by C30. Only part of L10 is used. HT current is supplied by full-wave rectifying valve (V6, Philips 1821). Smoothing by iron-cored choke L12 and resistance R26, in negative HT lead to

chassis, and condensers C33, C34. Fuse F1 protects the mains input circuit in case of accidental short-circuit. GB potential for V3 (when used with gramophone pick-up only) and V4 is obtained from drop along R26, while GB for V5 is obtained from a tapping on L12 and comprises the drop across R26 and part of that across L12.

COMPONENTS AND VALUES

CONDENSERS		Values (μF)
C1	Aerial coupling condensers ...	0.00008
C2	"Top" coupling condenser ...	0.00004
C3	"Bottom" coupling condenser ...	0.000001
C4	Band-pass "bottom" coupling condensers ...	0.05
C5	V1 SG decoupling ...	0.05
C6	V1 cathode by-pass ...	1.5
C7*	V1 anode decoupling ...	0.5
C8*	"Top" coupling condenser ...	0.000001
C9	Band-pass "bottom" coupling condensers ...	0.05
C10	V2 CG decoupling ...	0.05
C11	V2 SG decoupling ...	0.05
C12	V2 anode decoupling ...	0.5
C13	V2 cathode by-pass ...	0.5
C14	V2 anode LW trimmer ...	0.00064
C15	V3 CG condenser ...	0.0001
C16	V3 anode decoupling ...	1.0
C17	RF by-pass condensers ...	0.002
C18	Tone control condenser ...	0.002
C19	V3 to V4 AF coupling ...	0.002
C20	V4 anode decoupling ...	0.002
C21	V4 CG decoupling ...	0.5
C22	V4 to V5 AF coupling ...	0.05
C23	RF by-pass ...	0.0010
C24	V5 CG decoupling ...	0.5
C25	V5 SG decoupling ...	0.5
C26	Tone filter condenser ...	0.002
C27	Speaker isolating condensers ...	0.2
C28	"A" condensers ...	0.2
C29	"B" condensers ...	3.0
C30	HT smoothing condensers ...	4.0
C31	B-P pri. LW trimmer ...	0.00027
C32	B-P pri. MW trimmer ...	0.0001
C33	Band-pass pri. tuning ...	0.00043
C34	B-P sec. LW trimmer ...	0.00027
C35	B-P sec. MW trimmer ...	0.0001
C36	Band-pass sec. tuning ...	0.00043
C37	RF B-P pri. LW trimmer ...	0.00027
C38	RF B-P pri. MW trimmer ...	0.0001
C39	RF B-P pri. tuning ...	0.00043
C40	RF B-P sec. LW trimmer ...	0.00027
C41	RF B-P sec. MW trimmer ...	0.0001
C42	RF B-P sec. tuning ...	0.00043

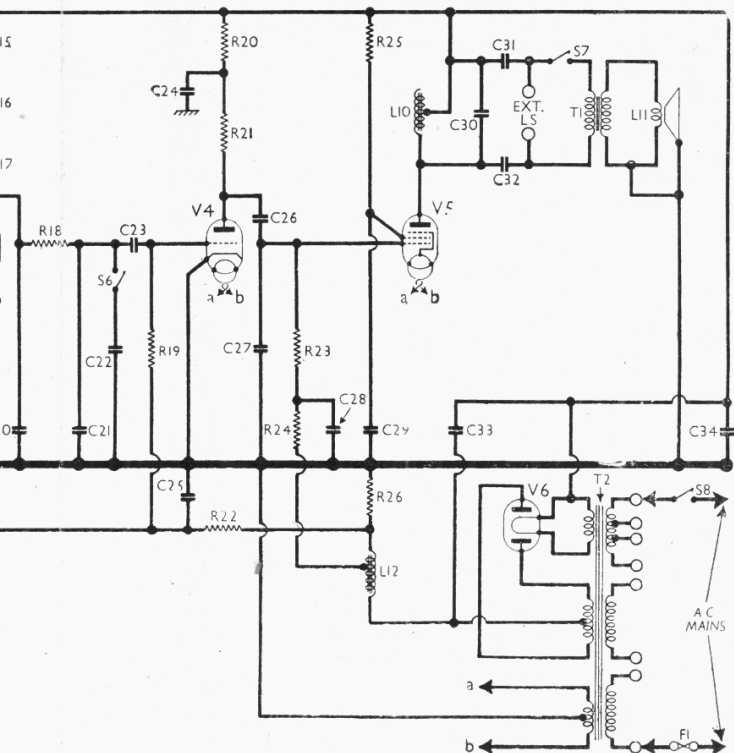

Circuit diagram of the Philips 630A Superinductance receiver. The tuned circuits associated with the aerial input and RF amplifier are both band-pass filters. It should be noted that, although the earthy ends of these circuits are returned to chassis via condensers C7 and C8, they are not at chassis potential to DC, and this applies to the screens of the gang condensers. R4 is the gain control, and R5 is V1 fixed GB resistance. Note that R2, R3 and R9 R10 are two potential dividers connected in parallel, and are returned to chassis via R4. The output from V5 is choke-capacity coupled to speaker transformer.

† Variable. ‡ Pre-set.
* In condenser block "A."
§ In condenser block "B."

RESISTANCES		Values (ohms)
R1	V1 CG decoupling ...	1,000,000
R2	V1 SG HT potential divider ...	50,000
R3	V1 gain control ...	40,000
R4	V1 fixed GB ...	6,200
R5	V1 anode HT feed resistances ...	400
R6	V1 anode HT feed resistances ...	16,000
R7	V2 CG resistance ...	2,000
R8	V2 SG HT potential divider ...	1,000,000
R9	V2 SG HT potential divider ...	50,000
R10	V2 GB resistance ...	64,000
R11	V2 anode decoupling ...	400
R12	PU series resistance ...	20,000
R13	V3 grid leak ...	320,000
R14	V3 anode decoupling resistances ...	200,000
R15	V3 anode load ...	16,000
R16	V3 anode load ...	10,000
R17	RF stopper ...	32,000
R18	V4 anode decoupling ...	100,000
R19	V4 anode decoupling ...	32,000
R20	V4 anode decoupling ...	640,000
R21	V4 anode load ...	25,000
R22	V4 CG decoupling ...	32,000
R23	V5 CG resistance ...	640,000
R24	V5 CG decoupling ...	100,000
R25	V5 SG HT feed ...	100,000
R26	Auto GB resistance ...	15,000
		100

OTHER COMPONENTS		Approx. values (ohms)
L1	Aerial band-pass primary coils ...	3.0
L2	Aerial band-pass secondary coils ...	23.0
L3	RF band-pass primary coils ...	3.0
L4	RF band-pass secondary coils ...	23.0
L5	V2 anode RF choke ...	30.0
L6	V5 anode output choke, total ...	1,000.0
L7	Speaker speech coil ...	6.5
L8	HT smoothing choke, total ...	1,200.0
L9	Speaker input { Pri. ...	500.0
L10	Speaker input { Sec. ...	0.8
L11	Speaker input { Pri., total ...	33.0
L12	Speaker input { Sec., total ...	0.05
T1	Mains { Heater sec. ...	0.15
T2	Mains { Rect. heat. sec. ...	340.0
S1-S5	Waveband switches ...	—
S6	Tone control switch ...	—
S7	Internal speaker switch ...	—
S8	Mains switch ...	—
F1	Mains circuit fuse ...	—

VALVE ANALYSIS

Valve voltages and currents given in the table below are those quoted for an average receiver by the makers. Measurements should be made with the volume control at maximum, with no signal input.

Voltages should be measured with a high-resistance voltmeter whose negative lead is connected to chassis.

Valve	Anode Voltage (V)	Anode Current (mA)	Screen Voltage (V)	Screen Current (mA)
V1 84VB	185	2.5	100	0.8
V2 84VB	165	4.0	110	1.3
V3 244V	57	3.5	—	—
V4 244V	110	2.8	—	—
V5 PM24A	240	14.0	170	5.0
V6 1821	255†	—	—	—

† Cathode to chassis, DC.

DISMANTLING THE SET

Removing Chassis.—Remove the two control knobs (recessed grub screws) from the front of the cabinet; remove the four bolts with metal washers, rubber washers and brass sleeves holding the chassis to the bottom of the cabinet.

The chassis may now be withdrawn to the extent of the speaker lead, which is sufficient for normal purposes.

To free chassis entirely, remove the cover from the input transformer on the speaker (one set screw), and unsolder the three leads from it.

When replacing, connect the red and green leads to the two tags above the transformer, and the black lead to the earthing tag on the right.

Removing Speaker.—The leads may be unsoldered as described above if it is desired to free the speaker entirely.

Otherwise, it may be withdrawn to the extent of its lead if the three clamp nuts round its edge are slackened and the clamps are swivelled.

When replacing, the transformer should be on the left, and the leads connected as previously described.

GENERAL NOTES

Switches.—S1-S5 are the waveband switches, in three ganged leaf-type units beneath the chassis, each section being in the screened compartment relative to the circuit with which it is associated. The units are lever operated by a push-pull movement of the tuning control spindle. In the MW position (knob pulled out), S1-S4 are closed, and S5 is open; in the LW position (knob pushed in) S1-S4 are open, and S5 is closed.

S6 is the QMB two-position tone control switch, mounted above the pick-up sockets at the rear of the chassis.

S7 is the QMB speaker switch, mounted above the external speaker sockets at the rear of the chassis.

S8 is the QMB mains switch, operated by an extension of the volume control R4 spindle.

Coils.—The four band-pass circuit coil units are of the Philips "Superinductance" type, consisting of Litzendraht wire wound on glass formers. They are contained in large diameter metal screens mounted on the chassis deck, and are of very low loss and carefully matched. Great care should be exercised if work becomes necessary on the coil units themselves. Unless it is absolutely necessary, the cans should not be disturbed at all.

L9 is a small unscreened coupling choke, mounted just below V2 holder in the under-chassis compartment.

L10 is the output choke, mounted close to V5 holder beneath the chassis. Of the

three connecting tags on it, only two are connected to the winding, the centre tag being used only as a bearer for other leads.

L12 is the HT smoothing choke, situated beneath the chassis near the voltage adjustment panel.

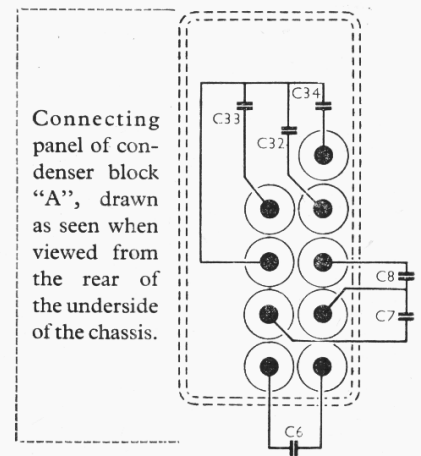

Tuning Condensers.—There are four of these, ganged together across the centre compartment beneath the chassis. Each is entirely encased in its own sealed metal screening can, and is unlikely ever to give trouble. The cans should not be opened if this can be avoided. In no case is the can connected directly to chassis, although all are returned there via condensers. The aerial circuit cans are connected to V1 cathode, and the RF amplifier condenser cans are actually at HT potential, so that short-circuits to chassis must be avoided.

Trimmer Condensers.—C35, C36; C38, C39; C41, C42; and C44, C45 are a special type of trimmer condenser. They consist of concentric brass tubes, one of which, the outer, can be slid along the other. Normally, the outer tube is sealed in position by paint, but it may be moved, if it is eased gently, for readjustment. After adjustment it should be sealed again with a dab of paint.

Condensers C3, C9.—These are of very small capacity, and consist of an extension on trimmers C39 and C42. The capacity is that between the metal at the end of the extension and the inner tube of each trimmer.

External Speaker.—Two sockets are provided at the rear of the chassis for a high impedance (about 10,000 Ω) external speaker. The sockets are isolated from the HT circuit by condensers C31, C32. The switch S7 permits the internal speaker to be muted.

Fuse F1.—This consists of a spring-loaded loop mounted on the mains transformer. If the fuse melts, the spring opens the gap rapidly ensuring a sudden break and an absence of arcing.

Mains Transformer T2.—The mains transformer has a special universal voltage primary winding, wound in three sections as shown in our circuit diagram. The two lower sections in the diagram are each wound for approximately 100 V, and the top section for about 50 V. Roughly

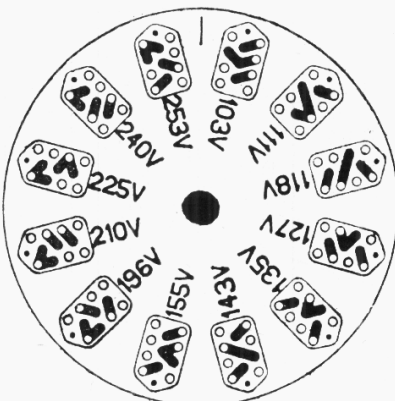

speaking, the two untapped sections are connected in series for, say, 200 V, and in parallel for 100 V. The tapped winding is then added in various ways to suit odd voltages.

The adjustment of the winding for the required mains voltage is carried out by positioning four metal links on the voltage adjustment panel according to a code diagram supplied with the receiver and attached to the panel cover. The voltage settings available are: 103, 111, 118, 127, 135, 143, 155, 196, 210, 225, 240 and 253.

The code diagram is a pink circular disc which can be swivelled round on its central fixing rivet. On the face are twelve patterns showing the link positions between the eleven fixed terminals on the adjusting panel, with the corresponding mean voltage ratings marked beside each.

The disc is reproduced in actual size in the diagram in col. 2. Each pattern is marked at its pointed end with a key in the form of a dot, which should be on the left of the operator when setting the adjustment, as it is on the actual panel.

On the reverse of the disc, the voltage range of each setting is printed, and after adjustment, the disc should be rotated until the appropriate range registers with a hole provided for it in the panel cover, so that the indication is visible from the rear of the receiver.

Chassis Divergencies.—The values quoted in our component tables are those found in our chassis, but the makers give the following alternative values: **R15**, 16,000 or 20,000 Ω ; **R16**, 10,000 or 12,500 Ω ; **R20**, 20,000 or 25,000 Ω ; **R19**, 500,000 or 640,000 Ω ; **R23**, 80,000 or 100,000 Ω ; **R24**, 100,000, 125,000 or 160,000 Ω ; **R1**, 1,000,000 or 1,250,000 Ω ; **R18**, 100,000 or 125,000 Ω ; **R22**, 500,000 or 640,000 Ω ; **C12**, 0.000064 or 0.00008 μF ; **C30**, 0.0016 or 0.002 μF . Also, it is important that condensers **C5** and **C11** are within ± 10 per cent. of each other.

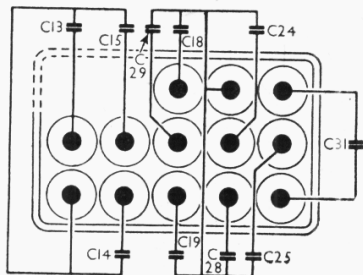

Connecting panel of condenser block "B", drawn as seen when viewed from the rear of the underside of the chassis.

Tuning Scale.—The tuning register consists of two rotary scales and a fixed indicator line. The larger scale is marked off in wavelengths near its outer circumference, and divided into twelve lettered zones on its inner circumference. The smaller scale is a vernier, and is divided into 100 divisions. It is geared to the larger scale by a 12 : 1 ratio, and makes a complete revolution to each zone on the large scale.

By this means, very accurate calibration is possible. The wavelength mark-

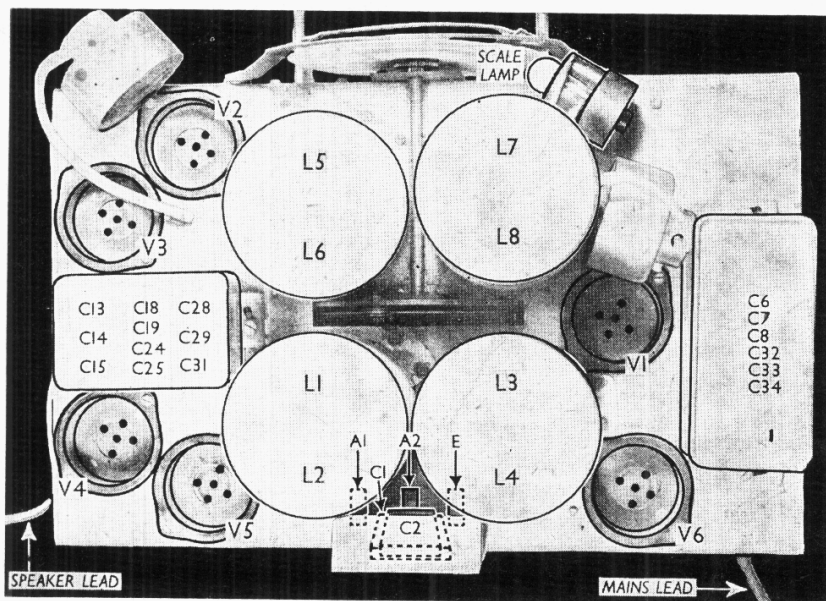

Plan view of the chassis. The tuning coils are in the four large circular cans. The connections to the two condenser blocks are seen from the underside of the chassis, and are shown in detail in the diagrams in cols. 3 and 4.

ings are only a rough indication, but once a known wavelength has been recorded with a letter/number, the setting can easily be repeated. An example can be seen in our "Circuit Alignment," where 225 m is given as B/45.

Wavechange Switch Seizure.—On switching over from one band to the other, a shutter obscures the wavelength markings of the unused band. The shutter is lever operated from the control spindle, and a short arm projecting from the upper edge runs in a guide formed of a slotted plate. The slot is closed at its ends, which form a stop to the excursion of the shutter.

These receivers are now fairly old, and in some cases, as in our sample, the short arm may have become bent with constant use, so that the shutter excursion exceeds its allotted range, and jams the wavechange switch movement. The remedy would appear to lie in removing the existing arm, which will break off if it is bent too often, and riveting on another in its place; otherwise the shutter must be removed altogether.

Condenser Blocks.—There are two of these, and in order to distinguish one from the other they have been designated "A" and "B." They are indicated in our chassis illustrations, and their connecting panels are shown in detail in the diagrams in cols. 3 and 4, where they are viewed in the position seen in our under-chassis illustration. Block "A" contains **C6, C7, C8, C32, C33** and **C34**; block "B" contains **C13, C14, C15, C18, C19, C24, C25, C28, C29** and **C31**.

CIRCUIT ALIGNMENT

With the gang at minimum, the line marking the left-hand edge of zone A on the main scale and the zero line on the vernier scale should register with the pointer line in the tuning aperture. Con-

nect the signal generator leads to **A1** and **E** sockets and turn the gain control to maximum. If the signal is not audible when fed in via socket **A1**, transfer the lead to **A2**.

MW.—Switch set to MW (knob out), tune to 225 m (B/45 on scale), feed in a 225 m (1,330 KC/S) signal, and adjust **C45, C42, C39** and **C36** as described in "General Notes" for maximum output.

LW.—Switch set to LW (knob in), tune to 1,000 m (C/0 on scale), feed in a 1,000 m (300 KC/S) signal, and adjust **C44, C41, C38** and **C35** for maximum output.

LOAN OF TECHNICAL INFORMATION

Dealers are requested to note when applying for the loan of technical information on receivers for which we have not published a *Service Sheet*, or for the loan of our file copies of *Service Sheets* which are out of print, that such applications must be accompanied by a written undertaking promising to return the material loaned within three working days of receipt.

This was explained in our notice of the conditions associated with such loans on *Service Sheet* 562, published March 28, 1942, and in another notice on page 253 of the same issue. For some reason this requirement does not appear to be fully understood, as in fifty per cent. of applications the undertaking is not given.

In the past we have in many cases forwarded the information without it, in order to avoid delay, but in future we shall be obliged in such cases to write back and ask for the required undertaking before forwarding the material, as some of it cannot be replaced and we cannot take the risk of its being lost.